

Instruction Sheet



Photoelectric Switch

ntermec

A **UNOVA** Company

Photoelectric Switch

P/N 3-500029-03

This part number includes the following items :

- 1 photoelectric switch Omron E3G-L77
- 1 Bracket :E39-L131
- 1 Cable : 933237042RISX with a sub D 9 pin male connector

Connectivity

The photoelectric switch is delivered with a detachable cable 3 meters long and a DB9 male connector IP 65 rated.

The cable has been designed to be fully compatible with the MaxiScan Connection System (P/N 0-531029-0X with X = 1, 6 or 7) and the MaxiScan 3010 Network System (P/N 3-500039-00) on the "synchros" port.

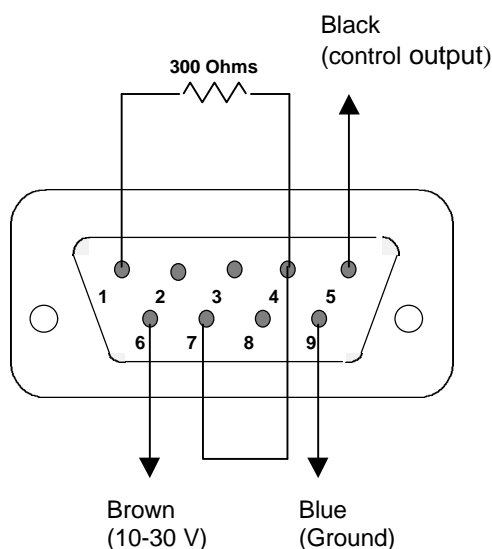

Photoelectric switch DB9 male connector (front view)

Setup

1. Use a screwdriver to open the front panel.
2. Set the selector switch to NPN position.
3. Mount the photoelectric switch on the bracket and fix it in position.
 - The cable position can be changed according to your requirements.
 - The object should move perpendicular to the switch (see Omron data sheet).
4. Connect the photoelectric switch to the MaxiScan Connection System or the MaxiScan 3010 "synchros" input port.
5. Turn the power on.
6. Follow the Distance Setting procedure in the Omron data sheet.
7. Use the EasySet software to activate the input synchronization of your MaxiScan 3300 or MaxiScan 3010.

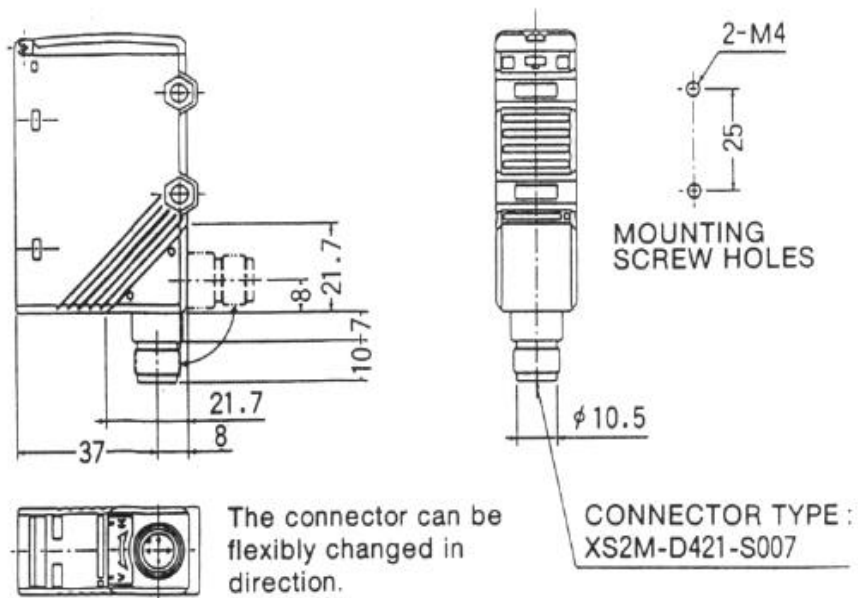

Photoelectric switch E3G-L77

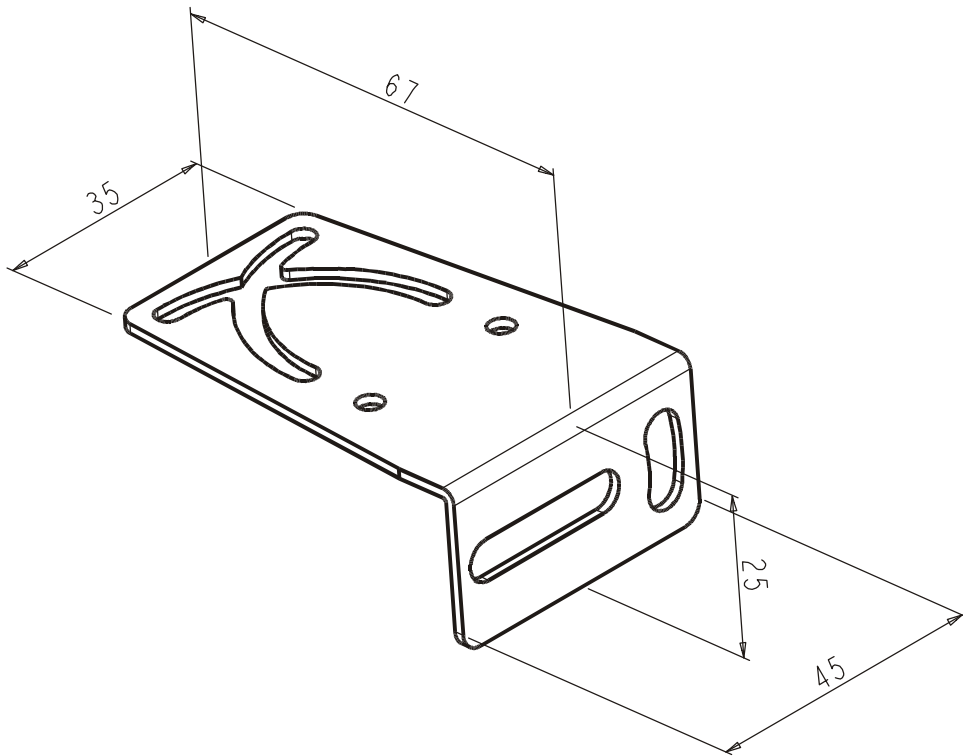

Bracket E39 L131

OMRON

Model **E3G-L7**

PHOTOELECTRIC SWITCH
DATA SHEET

Thank you for selecting OMRON product. This sheet primarily describes precautions required in installing and operating the product. Before operating the product, read the sheet thoroughly to acquire sufficient knowledge of the product. For your convenience, keep the sheet at your disposal.

© OMRON Corporation 1998 All Rights Reserved.

NOTE

- Be sure to follow the safety precautions below for added safety.
- Do not use the sensor under the environment with explosive or ignition gas.
 - Never disassemble, repair nor tamper with the product.
 - Keep the supply voltage within the specified range.
 - Do not use the sensor over the rated values.
 - Do not short-circuit the load. The sensor type has a load short-circuit protective function, but avoid keeping it short-circuited for a long time.
 - Do not use the sensor in the water.
 - Be careful not to confuse the terminal polarities.

NOTICE

- Do not use the product under the following conditions.
 - In the place exposed to the direct sunlight.
 - In the place where humidity is high and condensation may occur.
 - In the place where corrosive gas exists.
 - In the place where vibration or shock is directly transmitted to the product.
- Connections
 - Before turning on the power, make sure the supply voltage is below the maximum voltage level.
 - Routing the wires of the photoelectric switch with high potential power lines may cause malfunction or damage to it because of the inductive effects. Be sure to route the switch wires separated from the power lines or through an exclusive conduit.
 - For extending wires, use a cable 0.3mm² min. and 100m max. in length.
- Cleaning

Do not use thinner such as alcohol and benzene because it may damage a product.
- Power supply

When using a commercially available switching regulator, be sure to ground the FG (Frame Ground) and G (Ground) terminals. If this is not done, failure in operation may happen by switching noise of the regulator.
- Function of this sensor will be stable 100ms after turning on the power supply.
- Water-proof

Do not use in the water, rain, or outdoor.
- Control cover

Tighten the cover screws at the torque of 0.2 to 0.3 N·m to keep water-proof.

Installation

- Position the photoelectric switch so that direct sunlight, fluorescent light, incandescent light and any other strong rays do not come within the response angle.
- Sensors that are installed each other may cause mutual interference. Set them up with their optical axes not facing each other.
- Use 4M screws to secure the unit.
- Tighten the casing screws to 1.2N·m or lower.
- M12 connectors

Before connecting and disconnecting the connectors, be sure to turn off the power.

In connecting and disconnecting the connectors, be sure to hold the connector covers.
- Setup direction

Be sure to place the photoelectric switch so that its sensing face be parallel with (not tilted against) a detectable object.
- When detecting a glossy object, however, place the photoelectric switch tilted 5-10° to the glossy object. See the figure below.
- If there is something mirror-surface below the photoelectric switch, the switch performance may be adversely affected. Tilt the switch or keep it away enough from the mirror surface.

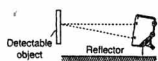
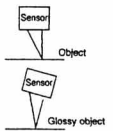

In placing the photoelectric switch, pay attention to moving direction of a detectable object. See the figure below.

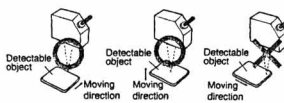

Be also careful when a detectable object has quite different colors or is made of different materials.

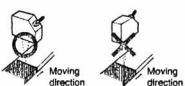

RATING/CHARACTERISTICS

Item	E3G-L73	E3G-L77
Connection	Cord type (Standard length 2M)	Connector type (M12 Connector)
Light source	Infrared LED (860nm)	
Supply voltage	10 to 30VDC (Including 10% ripple (p-p))	
Current consumption	60mA max	
Power consumption	60mA max	
Detectable range	0.2 to 2m (300×300mm white paper)	
Pre-settable distance	0.5 to 2m (300×300mm white paper)	
Response time (typical)	Run/Reset: 5ms each	
Hysteresis (typical)	10% of setting distance	
Reflectivity characteristics (black/white error)	±10% of setting distance (at detection distance of 1m)	
Control output	Load supply voltage 30VDC max, Load current 100mA max (residual voltage NPN output: 1.2V max PNP output: 2V max) Open collector output type (NPN/PNP output switching) L-ON/D-ON switching	
Timer function	-	
Circuit protection	Reverse power connection protection, Load shortcircuit protection, Mutual interference protection	
Ambient operating temperature	Operation: -25 to +55°C, Storage: -30 to 70°C (no freezing and condensation)	
Ambient operating humidity	Operation: 35 to 85%RH, Storage: 35 to 95%RH	
Protective design	IEC60529 IP67 (with protective cover)	
Material Case	Polybutylene (PBT)	
Material Lens	Acrylic resin (PMMA)	
Weight	About 150g	About 50g

OUTPUT STAGE CIRCUIT DIAGRAM

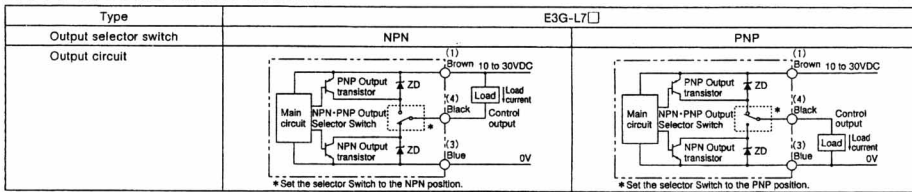

() Numbers in parentheses denote the connector pin numbers.

DISTANCE SETTING APPLICATION

Select the most suitable distance setting.

Application	Making setting without work. (Background only)	When distinction between objects is desired	Detecting a glossy work and normal work front of background.
Applications	• Detection of objects above a conveyor • Detection of objects a front of background.	• Minute difference detection • Detection of height difference	• Various glossy objects
Teaching	Normal one-point teaching	Normal two-point teaching	Zone one-point teaching
Detecting range and setting distance			
Teaching point	Teaching point: ① background Setting distance: just front of ①	Teaching point: ① background ② object Setting distance: center of ① to ②	Teaching point: ① background Setting distance: (A) and (B)

To set the setting distance to the maximum distance, take the maximum distance setting.

EXTERNAL DIMENSIONS

● E3G-L73

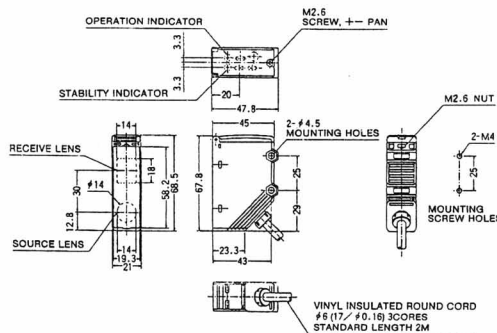

● E3G-L77

The dimensions left out in the figures are just the same as for the E3G-L73.

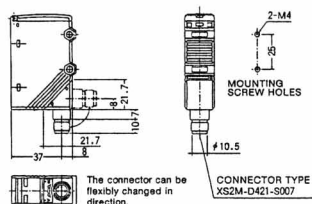

The connector can be flexibly changed in direction.
CONNECTOR TYPE: XS2M-D421-S007

NAMES OF SWITCHES AND INDICATORS
● E3G-L7

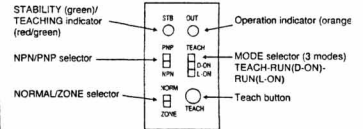

OPERATING PROCEDURE

- Make sure that the sensor is installed and the wires are connected as specified. Turn on the power.
- Set (teach) the distance level. See "Distance setting".
- Make sure that the MODE selector is at the RUN position.

DISTANCE SETTING (TEACHING)

Set the Mode Selector to TEACH. Set the selector to RUN to complete the distance setting.

[Normal one-point teaching]

- Set the NORMAL/ZONE selector to the NORMAL position.
- Direct the sensor toward the background and hold down the Teach button.
 - The TEACHING indicator (red) lights up.
- Move the MODE selector to the RUN position. (Select L-ON or D-ON.)

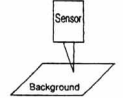

[Normal two-point teaching]

- Set the NORMAL/ZONE selector to the NORMAL position.
- Direct the sensor toward a work and hold down the Teach button.
 - The TEACHING indicator (red) lights up.
- Move the object the Teach button.
 - When the teaching is acceptable, all the TEACHING indicators (red) start flashing.
 - If the teaching is rejectable, the TEACHING indicators (red) start flashing.
- Make sure the teaching has been accepted. Set the MODE selector to the RUN position. (Using the RUN MODE selector, select L-ON or D-ON.)
 - If the teaching is rejectable, change the object position and distance. Repeat the above step 2 to 4.

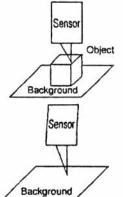

[Zone one-point teaching]

- Set the NORMAL/ZONE selector to the ZONE position.
- Direct the sensor toward the background and hold down the Teach button.
 - The TEACHING indicator (red) lights up. It turns to green soon.
- Set the MODE selector to the RUN position. (Select L-ON or D-ON.)

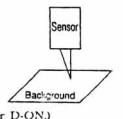

[Maximum distance setting]

- To set the sensor's distance differential to the maximum distance, take the following steps.
- Set the NORMAL/ZONE selector to the NORMAL position.
 - Hold down the Teach button for 3 seconds or longer.
 - The TEACHING indicator (red) lights up.
 - In 3 seconds, the TEACHING indicator (green) lights up.
 - Wait until the TEACHING indicator (green) lights up. Set the MODE selector to the RUN position. (Select L-ON or D-ON.)
- Note: EEPROM write error correction.
If during teaching the power is cut off or static electricity causes noises, there may be a write error (the RUN indicator starts flashing). In such case, do the teaching again.

PRECAUTIONS IN USING THE PRODUCT

- When the product is used under the circumstances below, ensure adherence to the limitations of the ratings and functions. Also, take countermeasures for safety precautions such as fail-safe installations.
- Use under the circumstances or environment which are not described in the instruction sheet.
 - Use for the equipment which require higher level of safety, such as nuclear devices, railroad, aircrafts, vehicles, combustion devices, amusement machinery, medical equipment, safety device.
 - Use for the applications where death, serious injury or property damage is possible and extensive safety precautions are required.